



# ΔJOY ENGINEERING LLP

IF YOU SATISFIED TELL OTHERS , IF NOT TELL US

An ISO : 9001:2015 Certified Company

**QUALITY • COMMITMENT • SERVICE**

| Rice Mill | Puffed Rice Mill | Flattened Rice Mill | Atta Mill | Pulses(Dall) Mill | feed Mill

---

Modern Milling Equipments , Installation & Fabrication



# MR. **SUKUMAR DAS**

| 22<sup>th</sup> November 1970 - 07<sup>th</sup> May 2023 |

## *Tribute to our Beloved Founder*

Ajoy Engineering Works was established in 1999 by late Mr. Sukumar Das with a passion to serve rice milling industry with modern technology & revolutionary inventions. He had a versatile knowledge of operating all types of milling machineries & equipments. He wanted to modernize the total milling section to improve the production capacity as well as quality in minimum time. Within a short period, the enterprise achieved a phenomenal growth as a manufacturer & exporter & supplier of all kind of modern milling machineries.

Sanjoy das also joined his father to serve this industry with more modern ideas at 2014. Under the dynamic leadership & technical assistance of his father Sanjoy das developed this enterprise more efficient in installation & modern milling. Ajoy Engineering Works become Ajoy Engineering LLP today. Ajoy das joined in 2020 and taking care of total production section. Both the brothers successfully carry forward the legacy by serving the milling industry with brilliant performed machines & ergonomic designs.

*You will be with Us forever.*



## SCREW CONVEYOR



Screw conveyors are used to convey bulk material from almost any position (vertical, horizontal, or at an incline) and are one of the most reliable methods of conveyance for moving material.

### Available in Various Materials

- Mild Steel (M.S.) powder coated And Painted
- Stainless Steel (S.S.)

Capacity Bran (TPH)	5	10	18
---------------------	---	----	----



AJOY ENGINEERING LLP

## CHAIN CONVEYOR

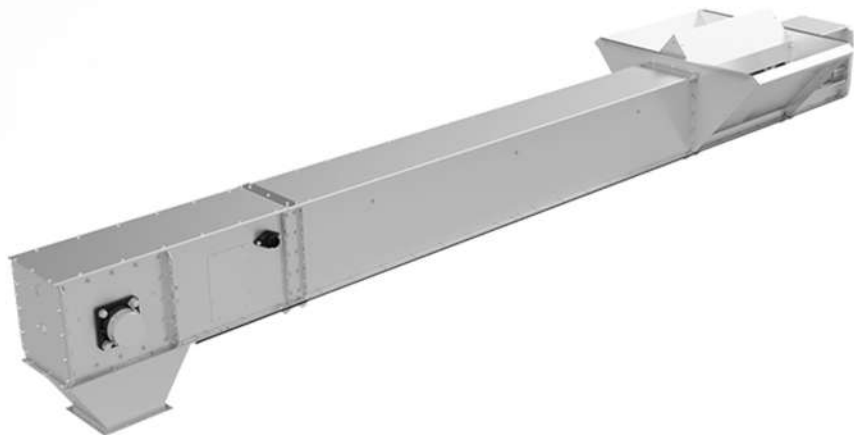

The chain conveyor has a series of gears connected into a continuous system by the chain. Chain conveyors are used for moving products down an assembly line and or around a manufacturing or warehousing facility.

### Available in Various Materials

- Mild Steel (M.S.) powder coated And Painted
- Galvanized Steel (G.I)
- Stainless Steel (S.S.)

Capacity Paddy (TPH)	25	30	45	55
Capacity Paddy (TPH)	12	30	45	55

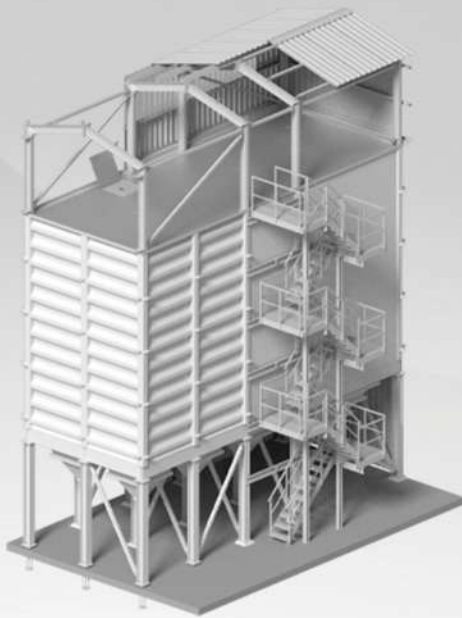

## SILO SYSTEMS



Prominence provides complete turnkey solution for grain storage. As per the customer requirements and available space, we make the most efficient and economical layout, to serve all the requirements.

Our highly experienced project team completes the project on time with safety.

### Available in Various Materials

- Mild Steel (M.S.) powder coated And Painted
- Stainless Steel (S.S.)

Silo Types	Hopper Bottom Silo	Paddy Silo	Rice Silo
------------	--------------------	------------	-----------



AJJOY ENGINEERING LLP



## HUSK ASPIRATOR



Husk Aspirators are designed to separate husk from the De-hulled paddy. They are equipped with a dynamically balanced blower which helps in the separation of the husk.

The paddy flows through the adjustable flaps to deliver husk-free rice and paddy.

The husk is conveyed through the pipeline to the husk yard.

### Available in Various Materials

- Mild Steel (M.S.) powder coated And Painted
- Stainless Steel (S.S.)

Product Name	Capacity Paddy (TPH)	Power Consumption (HP)
Husk Aspirator	3 - 5	3 - 5
Rice Aspirator	5 - 8	3 - 11
Paddy Aspirator	5 - 8	3 - 11

## DRUM CLEANER

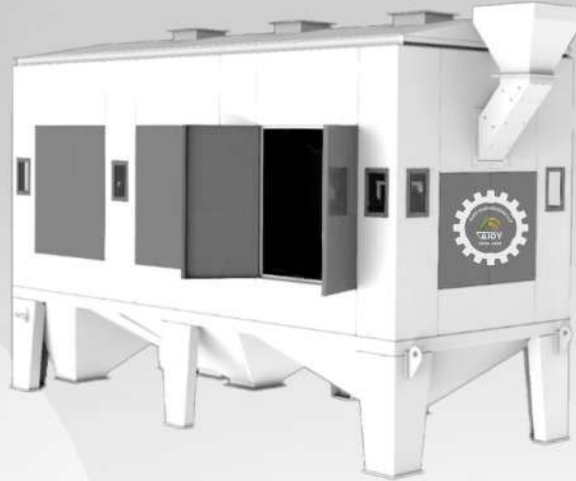

Drum Cleaner commonly known as the rotary cleaners are Classified under the preliminary cleaning section of the grain, principally designed to rotate continuously to separate over & undersized foreign particles from grain.

### Available in Various Materials

- Mild Steel (M.S.) powder coated And Painted
- Stainless Steel (S.S.)

Capacity Bran (TPH)	15-20	20-25
Power Consumption (HP)	5	7

## BUCKET ELEVATOR



This machine works to move grains from one place to another. This machine is designed in such a way that its current discharges positively and the force acting on it is the centrifugal force, spaced buckets dig into the material at input & then throw the material out of the discharge.

### Available in Various Materials

- Mild Steel (M.S.) powder coated And Painted
- Galvanized Steel (G.I)
- Stainless Steel (S.S.)

Bucket Wide (M.M)	125	150	175	200	250	300
Capacity TPH With B.D.750Kg/m <sup>3</sup>	8	13	18	24	42	55



## BRAN SEPERATOR 5 TO 8 TONS



The SuperSort separates rice tips from rice bran. The bran sifter has a throughput of up to one ton of bran input and is suitable for rice mills with throughputs of 5 to 8 tons per hour.

### Available in Various Materials

- Mild Steel (M.S.) powder coated And Painted
- Stainless Steel (S.S.)



ΔJOY ENGINEERING LLP

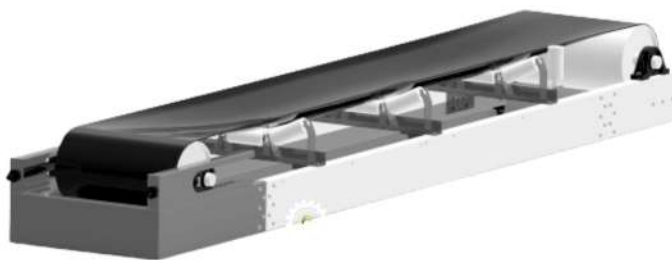

## BELT CONVEYOR



A belt conveyor system consists of two or more pulleys, with a closed loop of carrying medium—the conveyor belt—that rotates about them, this is used to transport large volumes of resources & agricultural materials, such as grain, seeds, feed etc.

### Available in Various Materials

- Mild Steel (M.S.) powder coated And Painted
- Stainless Steel (S.S.)

Product Name	Capacity Paddy (TPH)	Capacity Rice (TPH)
Grain Mover	15	20
Grain Mover	24	30

# TUBULAR SCREW CONVEYR

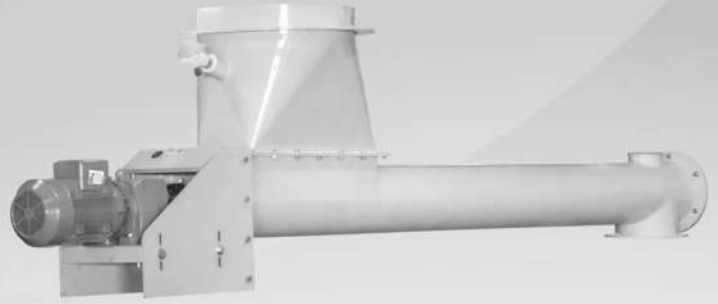

# SLIDE GATE



Pneumatic Slide Gate



Manual Slide Gate



ΔJOY ENGINEERING LLP

# CYCLONE



# RICE COOLER



# AIRLOCK



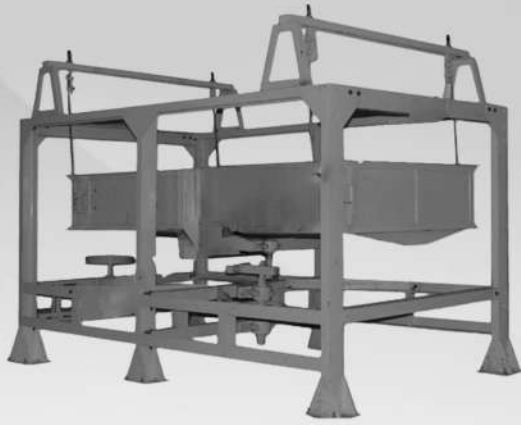

Crane Chalna

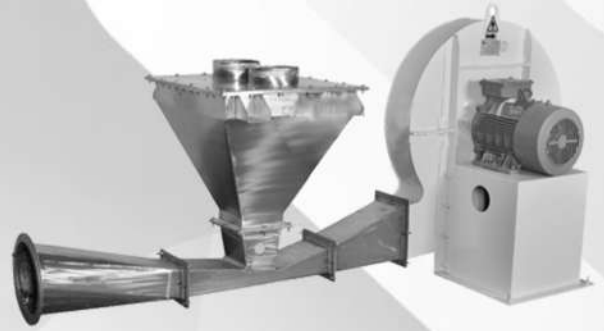

Venturi Blower



Dust Blower



Centrifugal Blower



ΔJOY ENGINEERING LLP

## HOPPER & ACCESSORIES



Hopper



Connection Hopper



Inlet Hopper



Bin Hopper



# Aspiration Ducting

Available in Various Materials

Galvanized Steel (G.I) Stainless Steel (S.S.)



STRAIGHT PIPE  
(SPOUT)



BEND 90°



BEND 60°



BUTTERFLY  
VALVES



AJJOY ENGINEERING LLP



BEND 45°



CLEANING DOOR

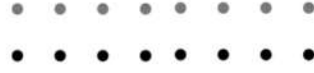

CONE

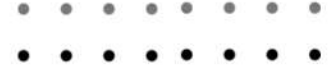

FALSE AIR INJET



BEND 30°



BRANCH PIPE

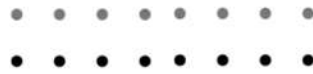

ASPIRATION  
HOPPER

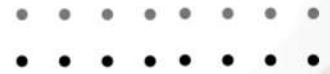

TRANSITION  
HOPPER

# SS Spouting

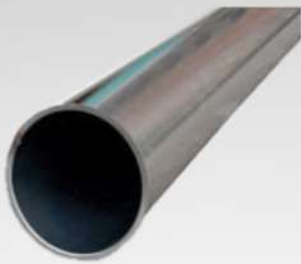

STRAIGHT PIPE



BRANCH PIPE



BRANCH PIPE  
SYMMETRIC



INSPECTION SPOUT  
HINGED COVER



AJJOY ENGINEERING LLP

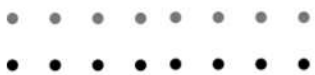

SEGMENT

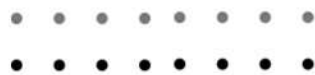

UNIVERSAL BEND

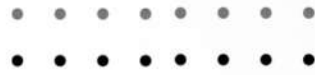

SPOUT SS



INSPECTION SPOUT  
RUBBER COVER

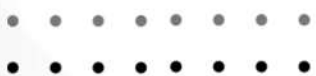

MANUAL  
DIVERTE R

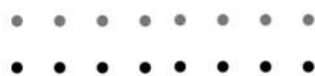

PNEUMATIC  
DIVERTE R

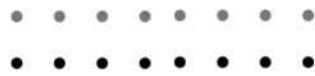

FLARING



TENSION RING  
WITH BOLT



AJOY ENGINEERING LLP



# Our Clientele



Chhajer Rice Mill Private Limited





## AJOY ENGINEERING LLP

### CORPORATE OFFICE :

607, PS ABACUS , NH12 , ACTION AREA IIE  
NEW TOWN, KOLKATA , WB , 700157 , INDIA

### BRANCH OFFICE :

S N BOSE ROAD , KADAMTALA  
SHIV MANDIR ( SILIGURI ) , DARJILING PIN 734011

### PLANT ADDRESS :

ALAMGANJ , NATUNGANJ , BURDWAN  
WB , 713102 , INDIA

### UNIT II :

BANKURA MORE , MACHKHANDA , BURDWAN  
WB , 713103 , INDIA

### OUR SALES SERVICE AVAILABLE

WEST BENGAL | ASSAM | TRIPURA | BIHAR | JHARKHAND | ODISHA

**EXPORT : BANGLADESH | NEPAL | SOUTH AFRICA**

Follow us on :



### CONTACT US:

Call us: +91-9775338666

Office : +91-9434188609

Email: info@ajoyengineeringllp.com

Website: www.ajoyengineeringllp.com

